

Temperature Control Steam Traps

SERIES TB

Temperature Control Steam Traps are bimetallic steam traps which do not follow the steam saturation curve. The discharge temperature can be adjusted manually, what allows to adopt these steam traps to a wide range of applications, where optional undercooling is possible and where sensible heat savings and flash steam reduction are desirable. These steam traps are perfectly fitted for reducing the steam consumption at steam main and steam tracing lines thus guaranteeing a high degree of energy savings.

Models TB7N & TB9N	with forged steel body for low and medium pressure applications
TBU4, TBU4B	with stainless steel body for low pressure tracing
TB1N	with steel body for low pressure applications
TB51/52	with forged steel body for high pressure applications
TBH71/72/81/82	with cast steel body for high pressure applications

Features

- All traps are equipped with the patented valve mechanism SCCV®-System (see pages 88 – 89).
- The SCCV®-System ensures a superior closing performance in the center of the port, greatly reduced wear of the internal parts and extended lifetime of the trap.
- Highly efficient in energy conservation – eliminates virtually 100% of steam loss.
- Continuous discharge of the condensate according to the adjusted temperature – not influenced by inlet pressure changes.
- Inline repairable – easy and quick replacement of the bimetal unit and the seat.
- Readjustment possible while the trap is in operation (for low pressure applications).
- All traps equipped with integral strainer.
- Can be installed both horizontally and vertically.

Suitable for:

TB7N	Steam main lines and tracing lines
TB9N	Steam main lines, tracing and small heat exchanger applications with specific condensate undercooling
TBU4, TB1N	Steam tracing lines
TB51/52	High pressure steam main lines
TBH71/72/81/82	High pressure steam main lines

Operating principle

■ cold condensate ■ hot condensate

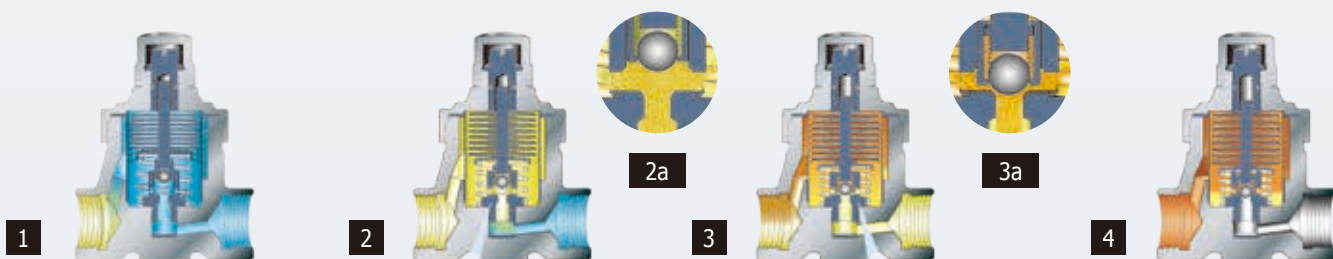

1) On start-up, the bimetal discs are all flat and the valve shaft is up with the valve fully open. Virtually all cold condensate and air are discharged.

2) As the temperature of the condensate increases, the bimetal discs begin to curve gradually and force the valve shaft and the valve holder to move down.

2a) Most of the condensate is still discharged quickly, since the valve and the holes in the fixed guide on the valve seat are still fully open.

3) When condensate with higher temperature (near to set temperature) flows in, the bimetal discs are curved even more and at the same time the valve shaft moves down and the valve holder closes the holes in the guide partially.

3a) The amount of condensate being discharged is reduced quickly. This prolongs the time that the hot condensate stays near the bimetal discs and the heat of the condensate is transferred to the bimetals much more effectively.

4) In case of very low condensate flow, the holes in the guide are closed completely by the valve holder and the valve will close precisely in the center of the seat. Normally, the trap is filled with hot condensate and the operation will rest in the state shown in figure 3. Condensate will be discharged continuously at a stable temperature (very close to the set temperature).

TB7N

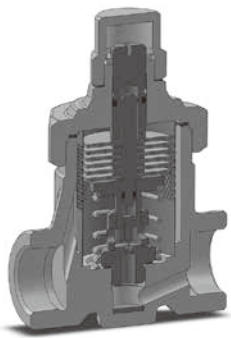

Available options TB7N

- with ball valve (TB7BN-C)
- with blow valve (TB7BN-R)
- with scale removal (TB7N-SR)

Special version TB7N-P

with maximum operating pressure 2,7 MPa / 392 psig

Special face-to-face dimensions available.

* **Curve 1** shows the trap's maximum capacity when discharging cold condensate.

** **Curve 2** shows the trap's maximum capacity when discharging hot condensate at a temperature of 10°C (18°F) below the adjusted temperature of the trap.

Standard factory setting*:

100°C at 1,0 MPa (212°F at 145 psig)

* Settings may differ in various regions.

For more information please contact us.

Max. allowable pressure (PMA) = 4,0 MPa (580 psig)

Max. allowable temperature (TMA) = 400°C (752°F)

Dimensions TB7N / TB7NW

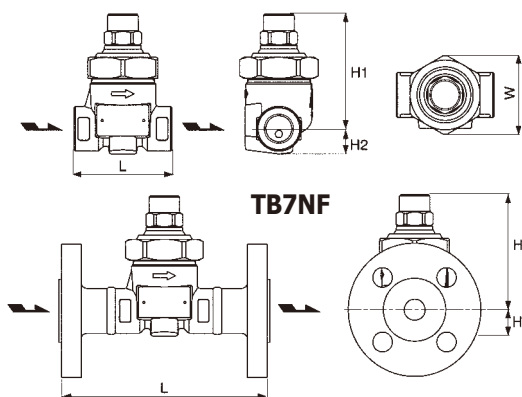

Capacity Chart TB7N

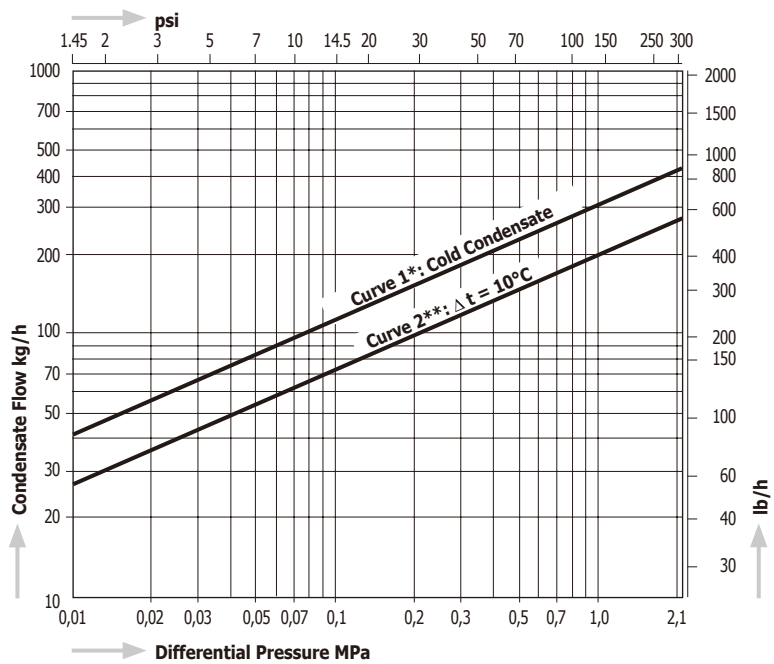

Temperature Stroke Chart TB7N

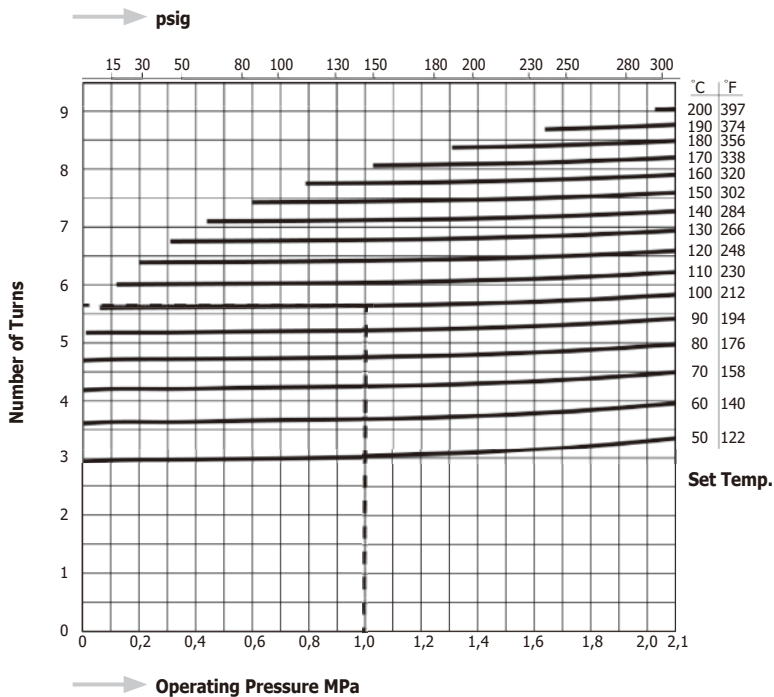

Model	Connections	Size	Max. Operating Pressure		Max. Operating Temperature		Adjustable Range		Dimensions (mm)				Dimensions (in)				Body Material	Weight	
			MPa	psig	°C	°F	°C	°F	L	H1	H2	W	L	H1	H2	W		kg	lb
TB7N	Screwed Rc, NPT	1/2"	2,1	305	350	662	50 - 200	122 - 392	70	18	56	2.75	0.7	2.2	Forged Steel A105	0,9	2.0		
		3/4"							80	19		3.1	0.75			1,0	2.2		
		1"							80	23		3.1	0.9			1,1	2.4		
TB7NW	Socket Weld JIS, ASME, DIN	1/2"	2,1	305	350	662	50 - 200	122 - 392	70	18	56	2.75	0.7	2.2	Forged Steel A105	0,9	2.0		
		3/4"							80	19		3.1	0.75			1,0	2.2		
		1"							80	23		3.1	0.9			1,1	2.4		
TB7NF	Flanged JIS, ASME	1/2"	2,1	305	350	662	50 - 200	122 - 392	145	18	56	5.7	0.7	2.2	Forged Steel A105	2,0-2,6 *1	4.4-5.7 *1		
		3/4"							150	19		5.7	0.75			2,5-3,4 *1	5.5-7.5 *1		
		1"							150	23		5.7	0.9			3,2-4,2 *1	7.0-9.3 *1		
	Flanged DIN PN40	DN15	150	82	18	56	5.9	3.2	0.7	2.2	2,6	5.7							
		DN20	150	82	18	56	5.9	3.2	0.7	2.2	3,4	7.5							
DN25	160	82	18	56	6.3	3.2	0.7	2.2	4,0	8.8									

*1 Depending on size and flange standard the weight of the traps differs. Please, look at our technical drawings.

TB9N

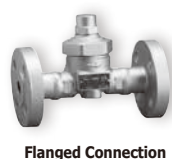
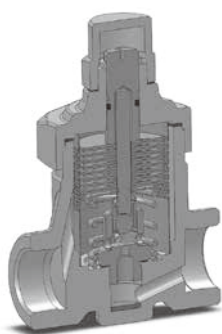

Available options TB9N

- with a ball valve (TB9BN-C)
- with a blow valve (TB9BN-R)
- with scale removal (TB9N-SR)

Special face-to-face dimensions available.

* **Curve 1** shows the trap's maximum capacity when discharging cold condensate.

** **Curve 2** shows the trap's maximum capacity when discharging hot condensate at a temperature of 10°C (18°F) below the adjusted temperature of the trap.

The dashed line shows the standard factory setting:

100°C at 0,5 MPa (212°F at 73 psig)

Max. allowable pressure (PMA):

4,0 MPa (580 psig)

Max. allowable temperature (TMA):

400°C (752°F)

Dimensions

TB9N / TB9NW

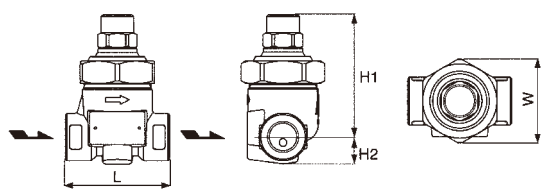

TB9NF

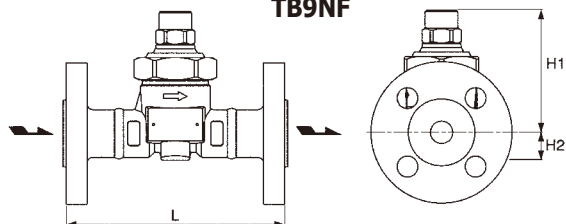

Capacity Chart TB9N

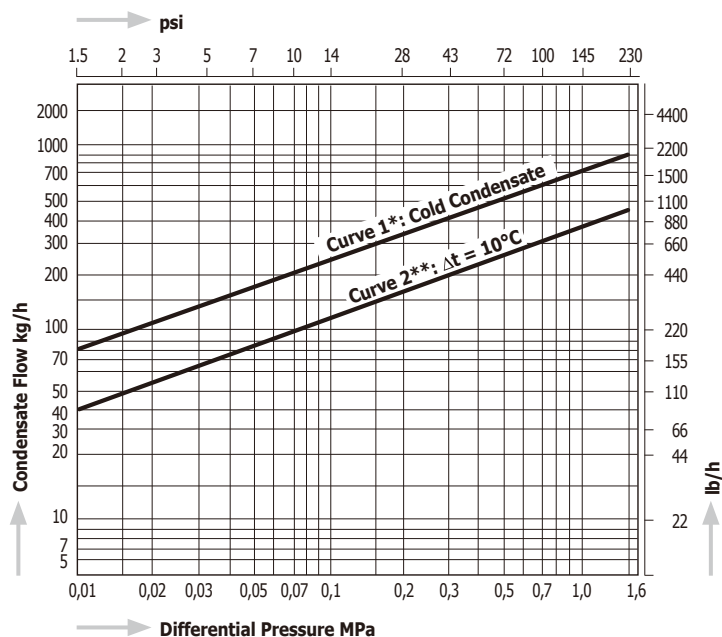

Temperature Stroke Chart TB9N

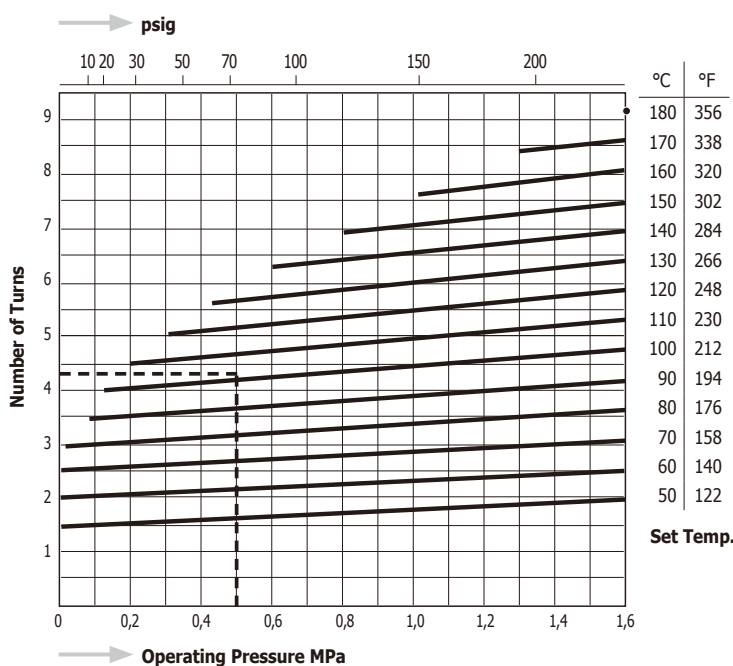

Model	Connections	Size	Max. Operating Pressure		Max. Operating Temperature		Adjustable Range		Dimensions (mm)				Dimensions (in)				Body Material	Weight	
			MPa	psig	°C	°F	°C	°F	L	H1	H2	W	L	H1	H2	W		kg	lb
TB9N	Screwed Rc, NPT	1/2"	1,6	230	350	662	50 - 180	122 - 356	70	82	18	56	2,75	3,2	0,7	2,2	Forged Steel A105	0,9	2,0
		3/4"							19		0,75		1,0		2,2				
		1"							23		0,9		1,1		2,4				
TB9NW	Socket Weld JIS, ASME, DIN	1/2"	1,6	230	350	662	50 - 180	122 - 356	70	82	18	56	2,75	3,2	0,7	2,2	Forged Steel A105	0,9	2,0
		3/4"							19		0,75		1,0		2,2				
		1"							23		0,9		1,1		2,4				
TB9NF	Flanged JIS, ASME	1/2"	1,6	230	350	662	50 - 180	122 - 356	145	82	18	56	5,7	3,2	0,7	2,2	Forged Steel A105	2,0-2,5 *1	4,4-5,5 *1
		3/4"									19				0,75			2,5-3,4 *1	5,5-7,5 *1
		1"									23				0,9			3,2-4,2 *1	7,0-9,3 *1
	Flanged DIN PN40	DN15	1,6	230	350	662	50 - 180	122 - 356	150	82	18	56	5,9	3,2	0,7	2,2	Forged Steel A105	2,6	5,7
		DN20									3,4				7,5				
		DN25									6,3				4,0			8,8	

*1 Depending on size and flange standard the weight of the traps differs. Please, look at our technical drawings.

TBU4, TBU4B

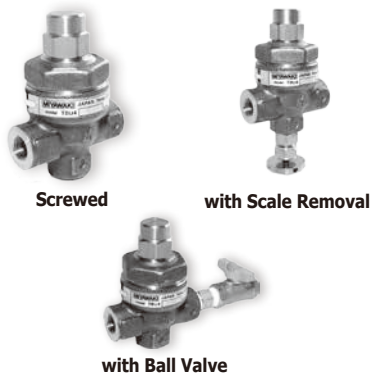
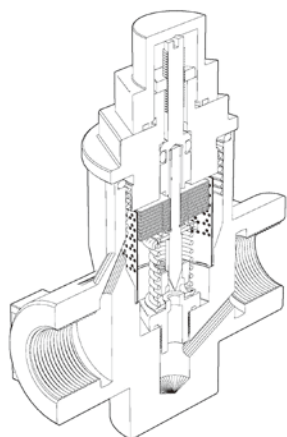

Available options TBU4

with a ball valve (TBU4B-C)
with scale removal (TBU4-SR)

Special version TBU4-10

Operating pressure range:

0,5 – 1 MPa (73 – 145 psig)

* **Curve 1** shows the trap's maximum capacity when discharging cold condensate.

** **Curve 2** shows the trap's maximum capacity when discharging hot condensate at a temperature of 10°C (18°F) (TBU4) / 5°C (9°F) (TB1N) below the adjusted temperature of the trap.

Standard factory setting:

70°C at 0,5 MPa; 158°F at 73 psig

The dashed line

shows the standard factory setting.

Dimensions

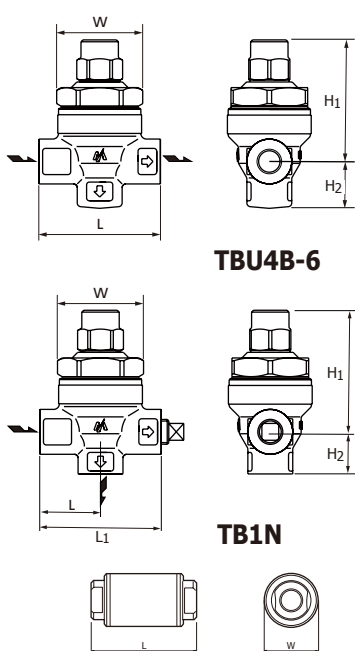

Capacity Chart TBU4/TBU4B-6

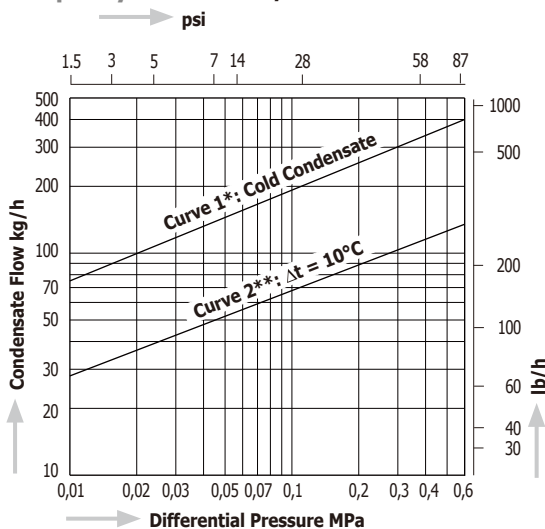

TB1N

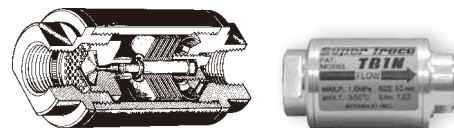

Capacity Chart TB1N

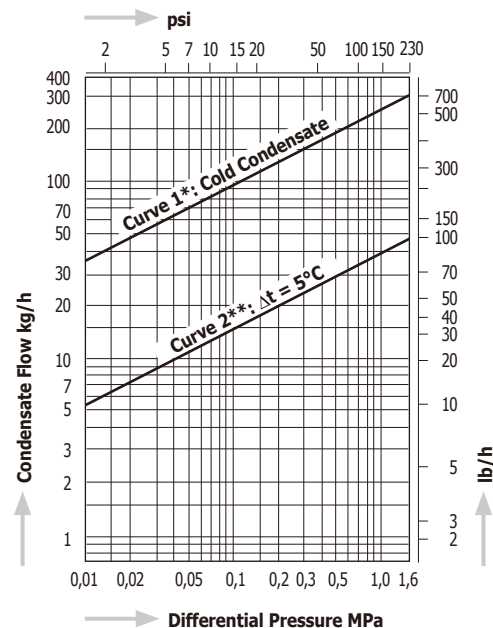

Temperature Stroke Chart TBU4/TBU4B-6

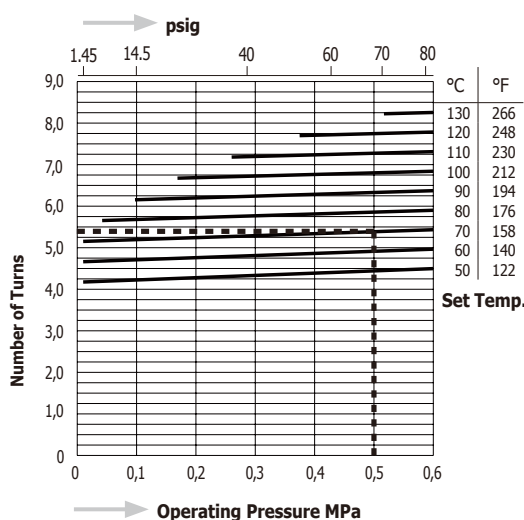

Temperature Stroke Chart TB1N

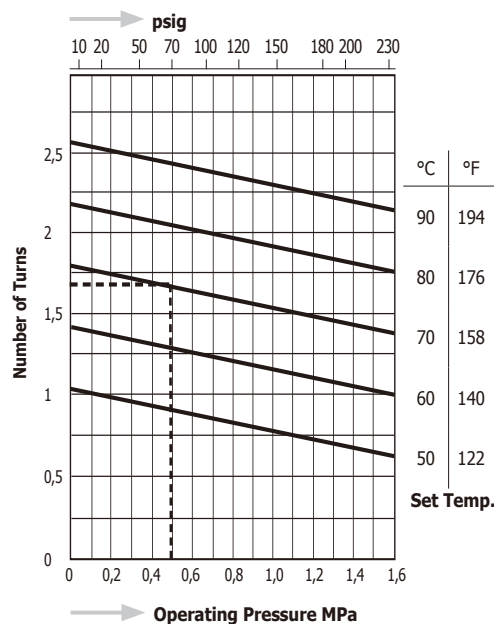

Model	Connections	Size	Max. Operating Pressure		Max. Operating Temperature		Adjustable Range		Dimensions (mm)					Dimensions (in)					Body Material	Weight	
			MPa	psig	°C	°F	°C	°F	L	L ₁	H ₁	H ₂	W	L	L ₁	H ₁	H ₂	W		kg	lb
TBU4-6	Screwed Rc, NPT	¼", 3/8"	0,6	87	220	428	50 – 130	122 – 266	65	–	25	–	2,6	–	1,0	–	–	–	Stainless Steel SCS F304	0,58	1,28
TBU4B-6									32,5	65	22,5	46	1,3	2,6	0,9	2,6	0,9				
TB1N	Screwed Rc, NPT	¼", 3/8"	1,6	230	350	662	50 – 90	122 – 194	70	–	–	–	38	2,8	–	–	–	1,5	Carbon Steel S25C	0,35	0,77

TB51, TB52

Capacity Chart
TB51/52-45

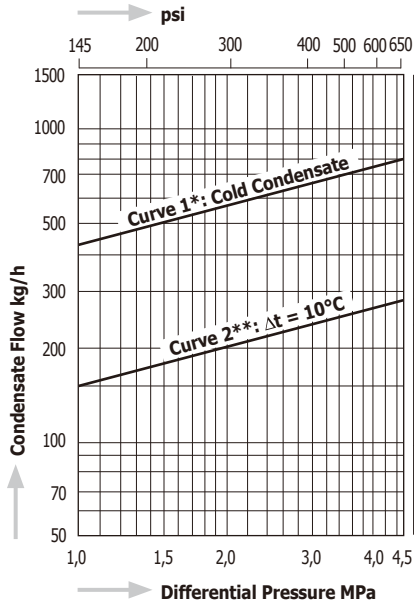

Capacity Chart
TB51/52-65

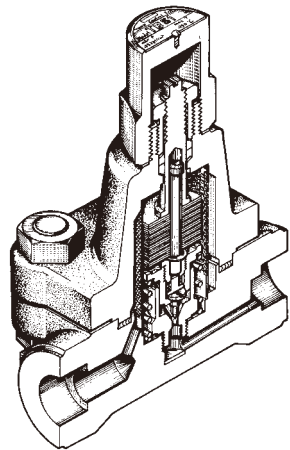
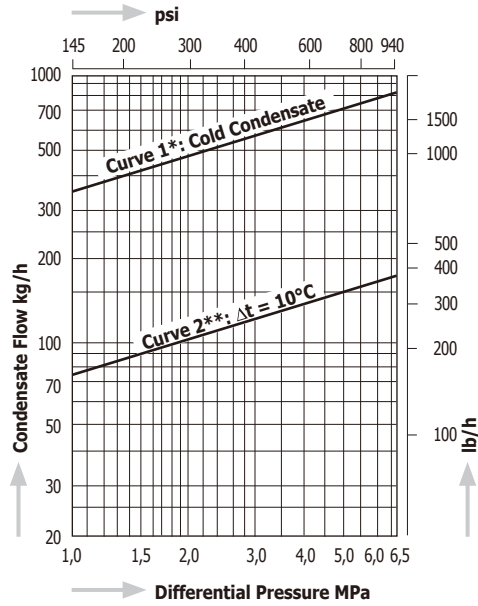

Screwed & Socket Weld

Flanged

Special face-to-face dimensions available.

* **Curve 1** shows the trap's maximum capacity when discharging cold condensate.

** **Curve 2** shows the trap's maximum capacity when discharging hot condensate at a temperature of 10°C (18°F) below the adjusted temperature of the trap.

Standard factory setting:

TB51-45, TB52-45:
180°C at 2,1 MPa; 356°F at 305 psig
TB51-65, TB52-65:
220°C at 4,4 MPa; 428°F at 638 psig

The dashed line

shows the standard factory setting.

Temperature Stroke Chart
TB51/52-45

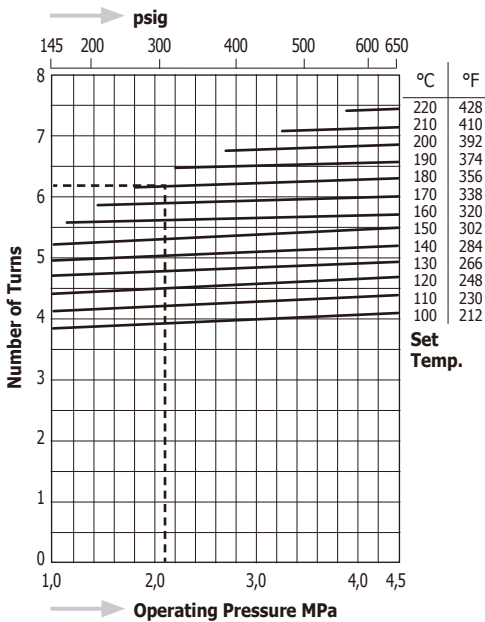

Temperature Stroke Chart
TB51/52-65

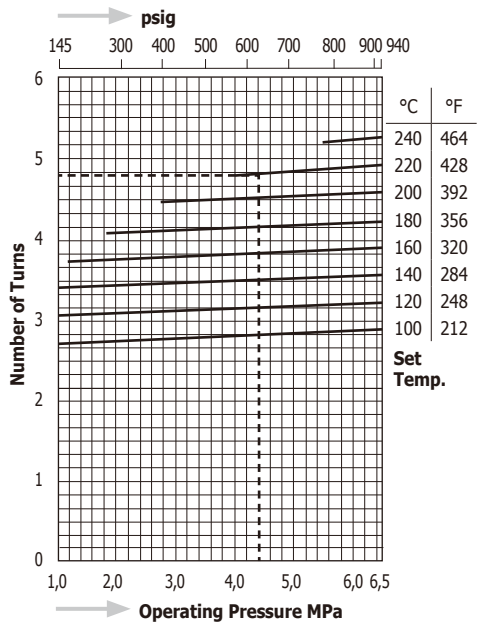

Dimensions TB51, TB52

TB51F, TB52F

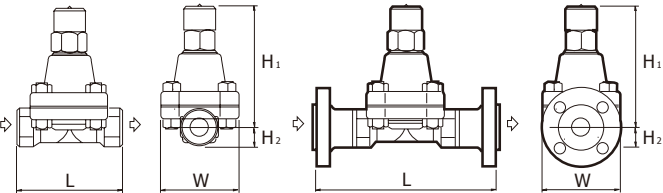
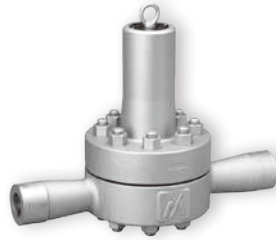
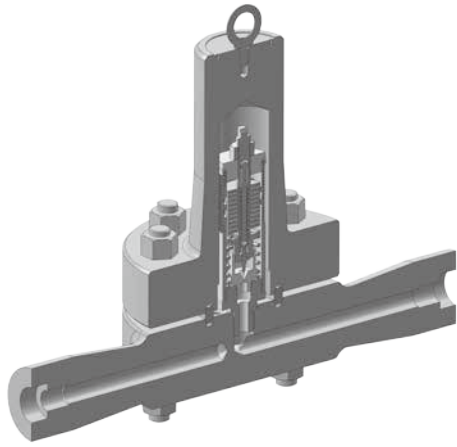

Table 1: Face-to-face dimensions / weights

Model	Size (in)	ASME 600 lb				DIN PN63 / PN100				JIS 63 K / ASME 900 lb			
		mm	in	kg	lb	mm	in	kg	lb	mm	in	kg	lb
TB51F TB52F	1/2"	200	7.9	7,3	16.1	210	8.3	9,4	20.7	220	8.7	9,6	21.2
	3/4"	210	8.3	8,5	18.7	230	9.1	11,4	25.1	230	9.1	11,1	24.5
	1"	240	9.4	9,6	21.2	230	9.1	12,5	27.6	240	9.4	12,1	26.7

Model	Connections	Size	Max. Operating Pressure		Max. Operating Temperature		Adjustable Range		Dimensions (mm)				Dimensions (in)				Body Material	Weight			
			MPa	psig	°C	°F	°C	°F	L	H1	H2	W	L	H1	H2	W		kg	lb		
TB51 (TB52)	45 65	Screwed Rc, NPT	1/2" - 1"	4,5	653	425	800	100 - 220	212 - 428	130	155	25	100	5.1	6.1	1.0	3.9	Forged Steel A105	5,7	12,6	
				6,5	943	(475)	(887)	100 - 240	212 - 464										5,7	12,6	
TB51 (TB52)W	45 65	Socket Weld JIS, ASME, DIN	1/2" - 1"	4,5	653	425	800	100 - 220	212 - 428	130	155	25	100	5.1	6.1	1.0	3.9		TB52: A182 F22	Table 1	Table 1
				6,5	943	(475)	(887)	100 - 240	212 - 464											Table 1	Table 1
TB51 (TB52)F	45 65	Flanged JIS, ASME, DIN	1/2" - 1"	4,5	653	425	800	100 - 220	212 - 428	Table 1	155	25	100	Table 1	6.1	1.0	3.9	Table 1	Table 1	Table 1	
				6,5	943	(475)	(887)	100 - 240	212 - 464										Table 1	Table 1	

TBH71, TBH72 TBH81, TBH82



TBH72, TBH81, TBH82
Socket Weld



TBH71
Flanged

Dimensions

TBH71- ...W
Socket Weld

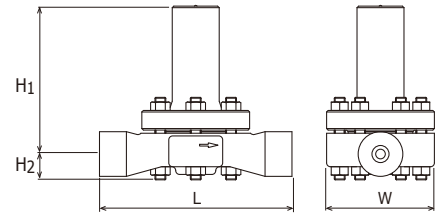

TBH71- ...F
Flanged

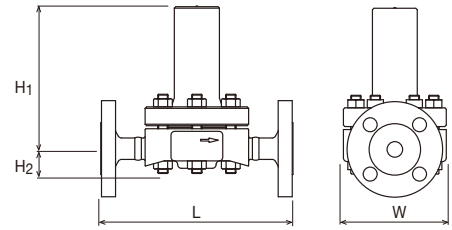

TBH72- ...W, TBH81- ...W, TBH82- ...W
Socket Weld

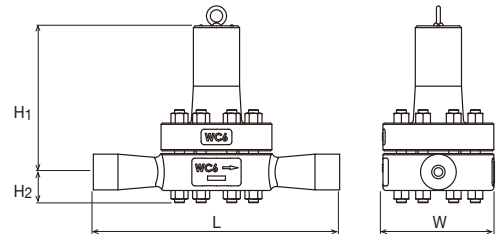

TBH72- ...F, TBH81- ...F, TBH82- ...F
Flanged

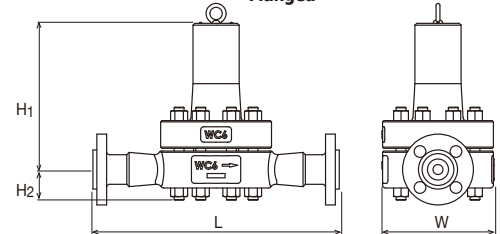

Standard factory settings

Model	MPa	psig	Model	MPa	psig
TBH71-80	6,5 (210°C)	942 (410°F)	TBH72-80	6,5 (210°C)	942 (410°F)
TBH71-105	8,0 (230°C)	1160 (446°F)	TBH72-105	8,0 (230°C)	1160 (446°F)
TBH81-150	10,5 (250°C)	1522 (482°F)	TBH82-150	10,5 (250°C)	1522 (482°F)
TBH81-200	15,0 (270°C)	2175 (518°F)	TBH82-200	15,0 (270°C)	2175 (518°F)

Pressure shell design conditions

Model	PMA		TMA	
	MPa	psig	°C	°F
TBH71-80	11,8 (425°C)	1711 (800°F)	593 (1,3MPa)	1100 (188 psig)
TBH71-105				
TBH72-80	25,0 (492°C)	3625 (918°F)	593 (3,7MPa)	1100 (536 psig)
TBH72-105				
TBH81-150	25,0 (492°C)	3625 (918°F)	593 (3,7MPa)	1100 (536 psig)
TBH81-200				
TBH82-150	25,0 (520°C)	3625 (968°F)	593 (5,9MPa)	1100 (856 psig)
TBH82-200	25,0 (538°C)	3625 (1000°F)	593 (7,3MPa)	1100 (1059 psig)

Model	Connections	Size	Max. Operating Pressure		Max. Operating Temperature		Adjustable Range		Dimensions (mm)				Dimensions (in)				Body Material	Weight	
			MPa	psig	°C	°F	°C	°F	L	H1	H2	W	L	H1	H2	W		kg	lb
TBH71-80W	Socket Weld JIS, ASME, DIN	½" – 1"	8,0	1160	470	878	100 – 260	212 – 500	250	195	33	140	9.8	7.7	1.3	5.5	Cast Steel A217WC6	13	28.6
TBH71-105W			10,5	1522			100 – 280	212 – 536										13	28.6
TBH81-150W			15,0	2175			100 – 300	212 – 572										29	63.8
TBH81-200W			20,0	2900			100 – 320	212 – 608										29	63.8
TBH71-80F	Flanged JIS, ASME, DIN	½" – 1"	8,0	1160	470	878	100 – 260	212 – 500	260	195	33	140	10.2	7.7	1.3	5.5	Cast Steel A217WC6	19*	41.8*
TBH71-105F			10,5	1522			100 – 280	212 – 536										19*	41.8*
TBH81-150F			15,0	2175			100 – 300	212 – 572										38*	83.6*
TBH81-200F			20,0	2900			100 – 320	212 – 608										38*	83.6*

Model	Connections	Size	Max. Operating Pressure		Max. Operating Temperature		Adjustable Range		Dimensions (mm)				Dimensions (in)				Body Material	Weight	
			MPa	psig	°C	°F	°C	°F	L	H1	H2	W	L	H1	H2	W		kg	lb
TBH72-80W	Socket Weld JIS, ASME, DIN	½" – 1"	8,0	1160	550	1022	100 – 260	212 – 500	400	268	50	180	15.7	10.6	2.0	7.1	A217WC6	29	63.8
TBH72-105W			10,5	1522			100 – 280	212 – 536										29	63.8
TBH82-150W			15,0	2175			100 – 300	212 – 572		37	81.4								
TBH82-200W			20,0	2900			100 – 320	212 – 608		68	149.6								
TBH72-80F	Flanged JIS, ASME, DIN	½" – 1"	8,0	1160	550	1022	100 – 260	212 – 500	400	268	50	180	15.7	10.6	2.0	7.1	A217WC6	35*	77.0*
TBH72-105F			10,5	1522			100 – 280	212 – 536										38*	83.6*
TBH82-150F			15,0	2175			100 – 300	212 – 572		46*	101.2*								
TBH82-200F			20,0	2900			100 – 320	212 – 608		76*	167.2*								

* The weight refers to 1" flanged type. Depending on the size and flange standard the weights may differ.

Forged Steel (A182F91) as body material for TBH72 and TBH82 is available as special design. For more details, please contact MIYAWAKI Inc. or an authorized representative.

Bimetal Temperature Control Trap – High Pressure **SERIES TB**

Capacity Charts

Temperature Stroke Charts

TBH71 - 80

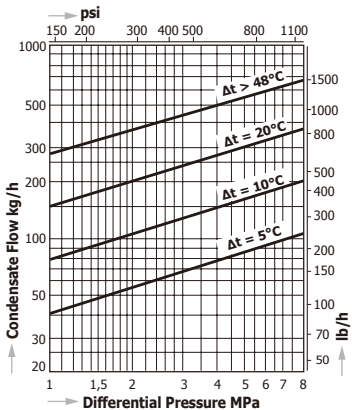

TBH72 - 80

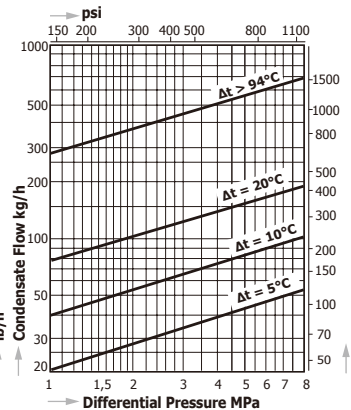

TBH71 - 80

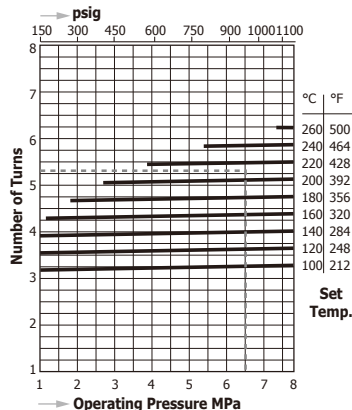

TBH72 - 80

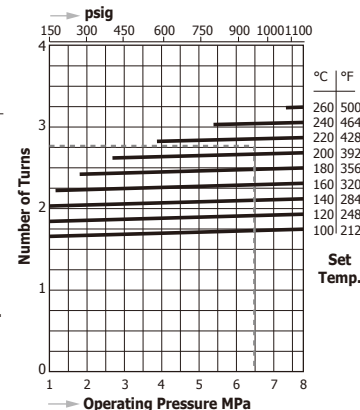

TBH71 - 105

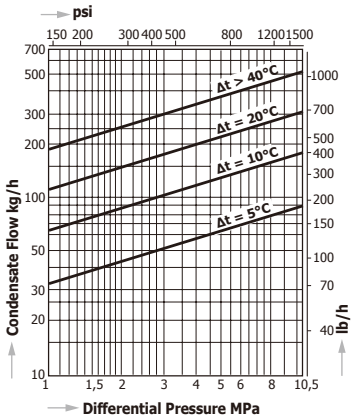

TBH72 - 105

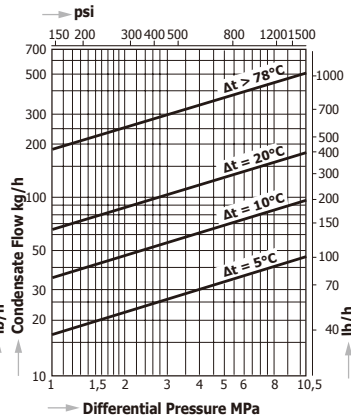

TBH71 - 105

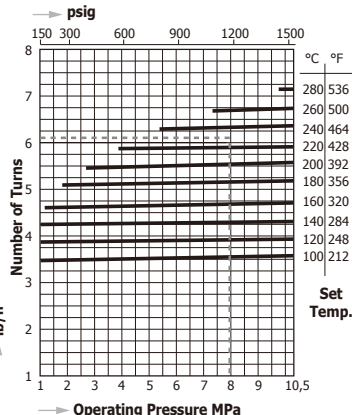

TBH72 - 105

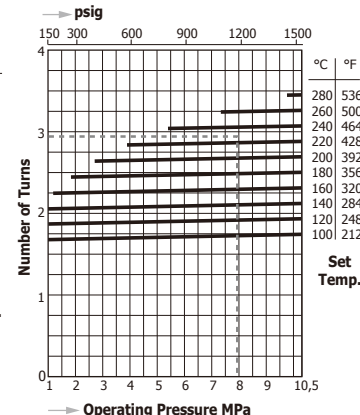

TBH81 - 150

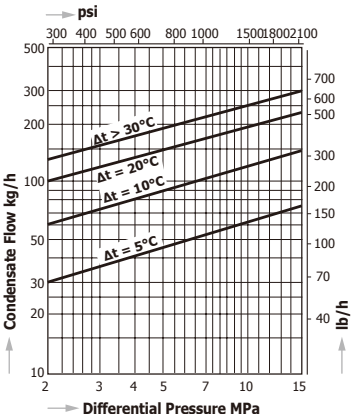

TBH82 - 150

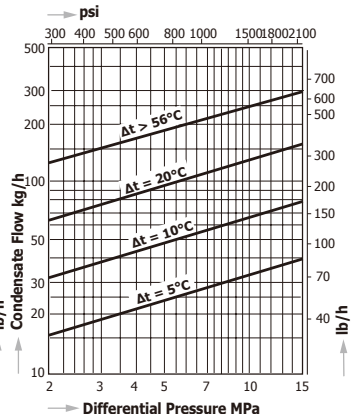

TBH81 - 150

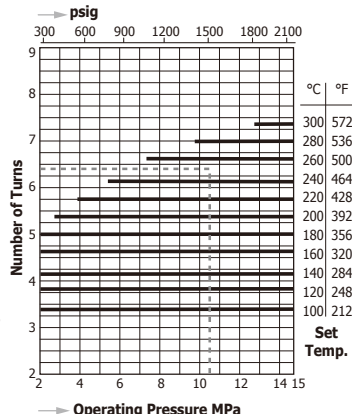

TBH82 - 150

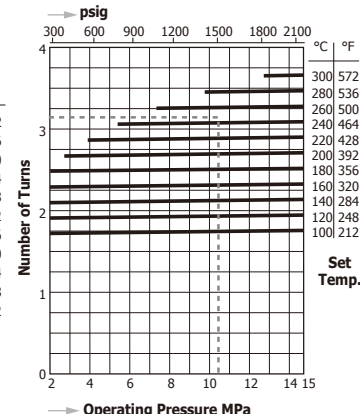

TBH81 - 200

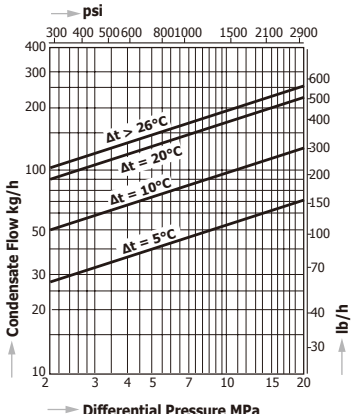

TBH82 - 200

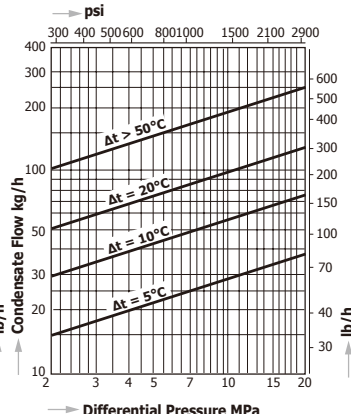

TBH81 - 200

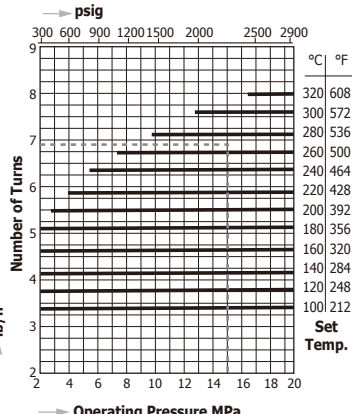

TBH82 - 200

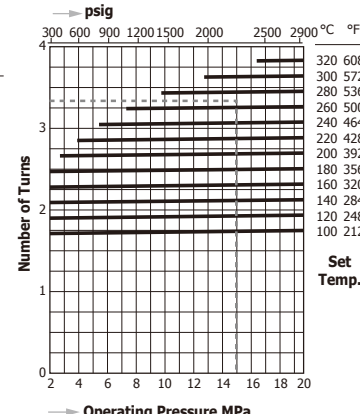

The dashed line shows the standard factory setting.

TB7N

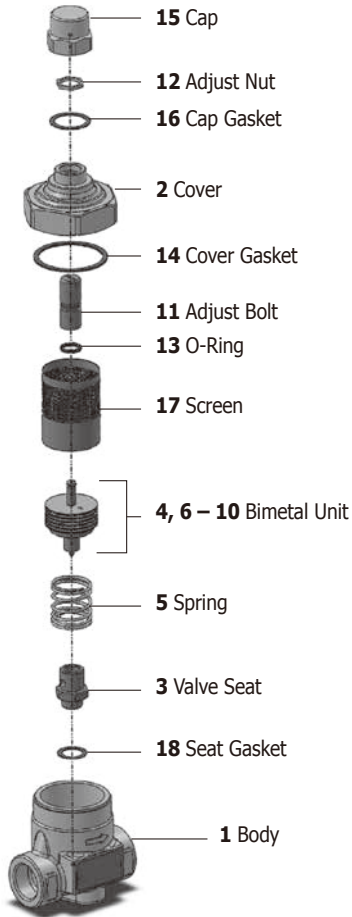

TB9N

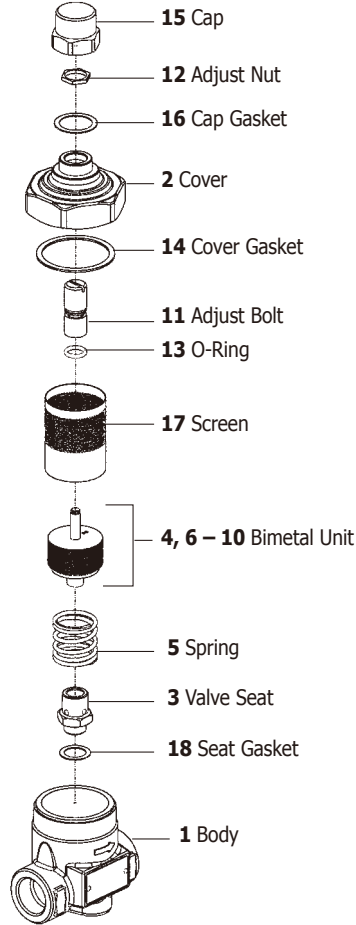

TBU4, TBU4B

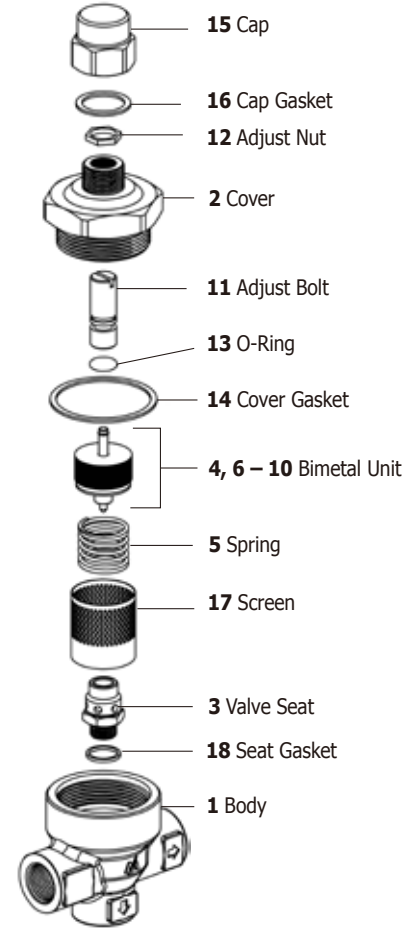

TB1N

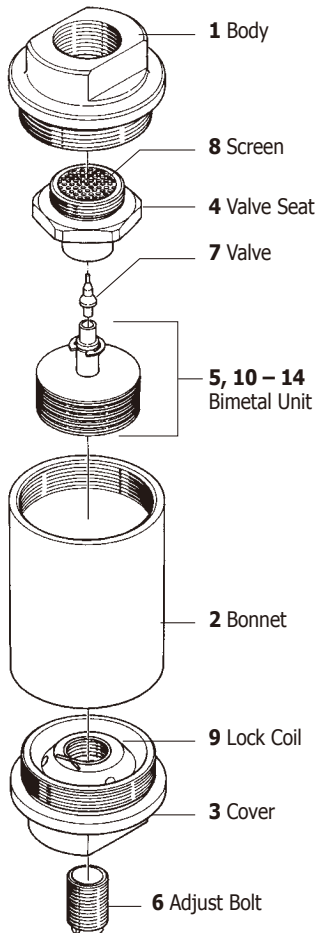

TB51, TB52

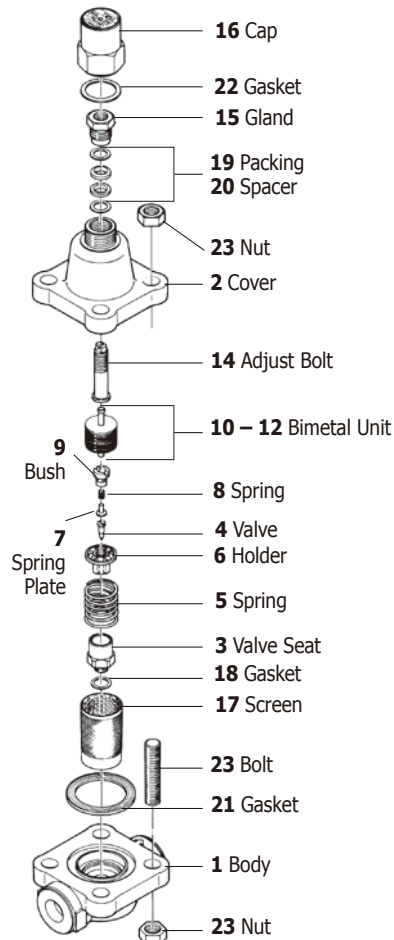

TBH71, TBH72, TBH81, TBH82

